

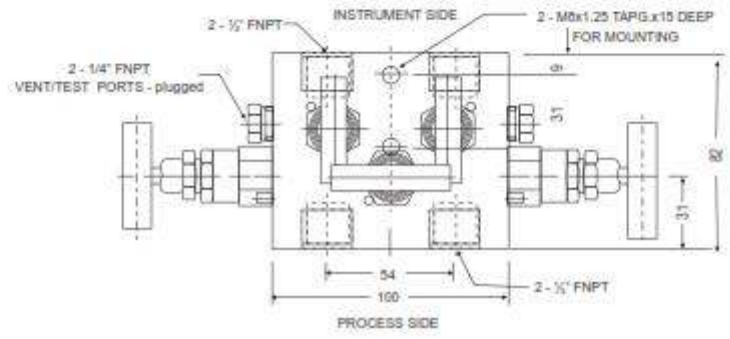

PRESSURE	VACCUM	DP	FLOW	VELOCITY	LEVEL	TEMPERATURE	CONDUCTIVITY	pH	VIBRATION
----------	--------	----	------	----------	-------	-------------	--------------	----	-----------

MODEL : 5VR

With threaded female ports on front side and back side for instrument and process connections. The two vent bonnets along with equalizing bonnet are positioned on the topside. The two isolation bonnets are positioned on left and right hand sides

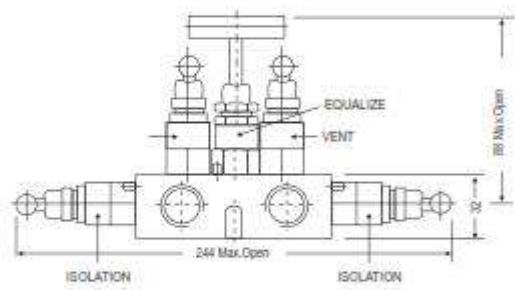

STANDARD CONNECTION

Product	Process Side	Instrument Side	Vent/Test
5VR	1/2" NPT female	1/2" NPT female	1/4" NPT female



CONTACT DETAILS

B-501/504, 5th floor, Raunak Arcade, Near THC Hospital, Gokhale Road, Naupada, Thane(w) 400602. Maharashtra INDIA
 ● Telefax Nos.: 91-22-25301330 / 31 / 32 ● Skype: nitinkelkarskype ● Gtalk: nkstruments2006



MODEL : 5VK

With threaded female ports on front side for instrument connection along with extended Flange for process connection. The two vent bonnets along with equalizing bonnet is positioned on the top side. The two isolation bonnets are positioned on left and right hand sides.

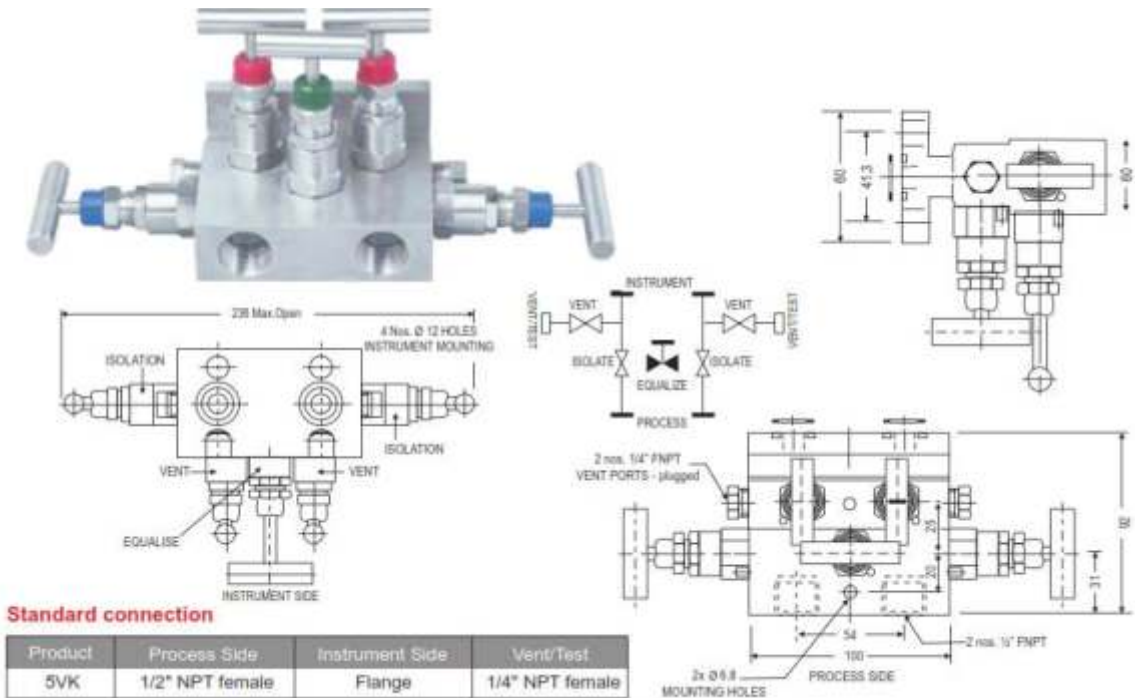

MODEL : 5VH

With Flange horizontal port inlets and Flange port outlets. The vent/test ports are positioned on the bottom side. The isolating and venting bonnets are positioned on the left and right hand side and the equalizing bonnet is positioned on the top side. Designed for direct mounting

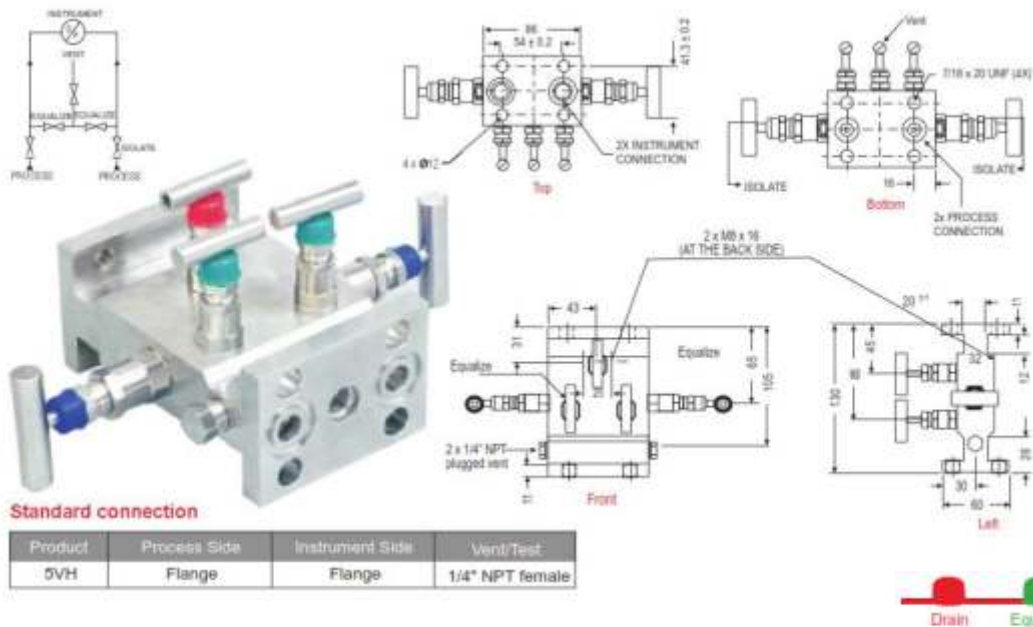

CONTACT DETAILS

B-501/504, 5th floor, Raunak Arcade, Near THC Hospital, Gokhale Road, Naupada, Thane(w) 400602. Maharashtra INDIA
 ● Telefax Nos.: 91-22-25301330 / 31 / 32 ● Skype: nitinkelkarskye ● Gtalk: nkinstruments2006



Process Control Instruments for Indication and Control of:

PRESSURE	VACCUM	DP	FLOW	VELOCITY	LEVEL	TEMPERATURE	CONDUCTIVITY	pH	VIBRATION
----------	--------	----	------	----------	-------	-------------	--------------	----	-----------

MODEL : 5VA

With threaded vertical port inlets and outlets. The isolating and venting bonnets are positioned on the left and right hand side and the equalizing bonnet is positioned on the front side. Designed for remote mounting.

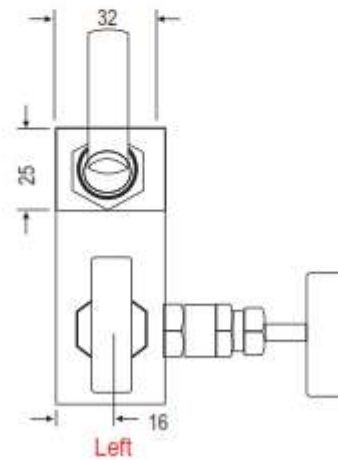
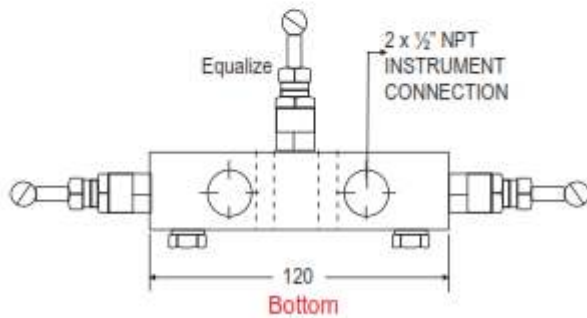
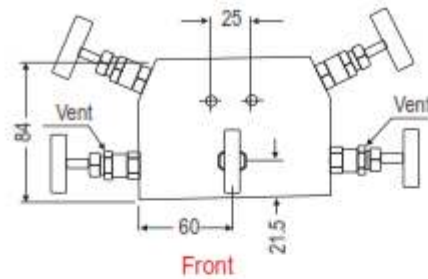
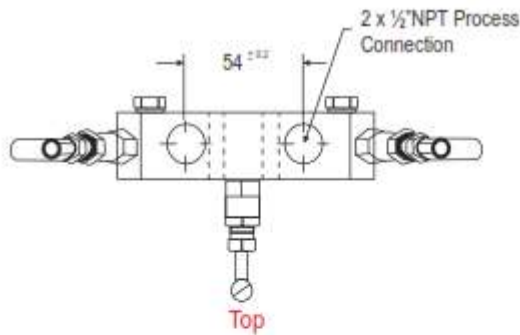
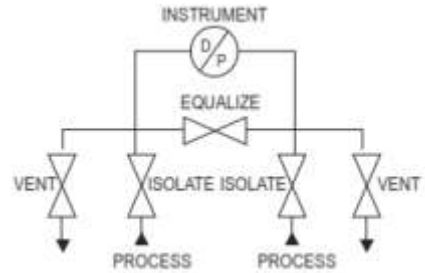

STANDARD CONNECTION

Product	Process side	Instrument side	Vent/Test
5VA	1/2" NPT female	1/2" NPT female	1/4" NPT female



CONTACT DETAILS

B-501/504, 5th floor, Raunak Arcade, Near THC Hospital, Gokhale Road, Naupada, Thane(w) 400602. Maharashtra INDIA
 ● Telefax Nos.: 91-22-25301330 / 31 / 32 ● Skype: nitinkelkarskye ● Gtalk: nkstruments2006

E-Mail: sales@nkstruments.com

Web: www.nkstruments.com



PRESSURE	VACCUM	DP	FLOW	VELOCITY	LEVEL	TEMPERATURE	CONDUCTIVITY	pH	VIBRATION
----------	--------	----	------	----------	-------	-------------	--------------	----	-----------

MODEL : 5VG

With threaded vertical port inlets and outlets. The vent/test ports are positioned on the bottom and top of the body. The isolating bonnets are positioned on the left and right hand side and the venting and equalizing bonnets are positioned on the front side. Specially designed for remote mounting to field meters, differential transmitters and chart recorders on gas service allowing fail safe configuration preventing pressure loss from the high to low pressure impulse lines.

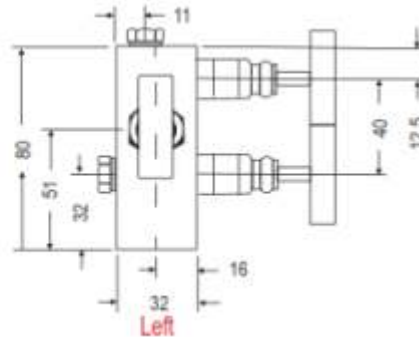
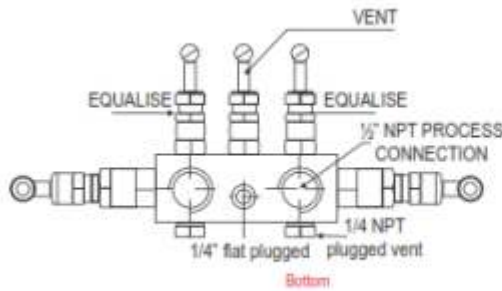
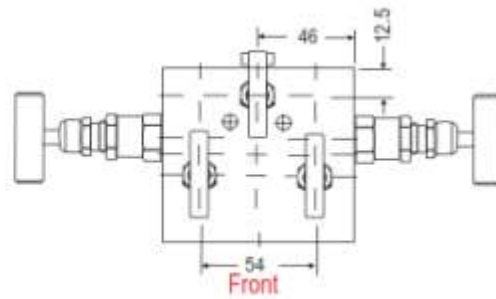
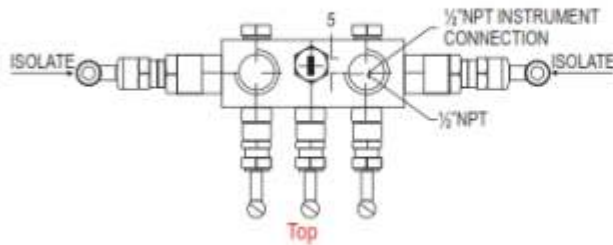
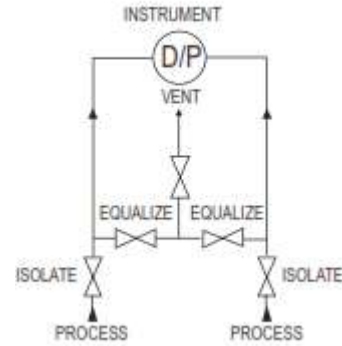

Standard connection

Product	Process Side	Instrument Side	Vent/Test
5VG	1/2" NPT female	1/2" NPT female	1/4" NPT female



CONTACT DETAILS

B-501/504, 5th floor, Raunak Arcade, Near THC Hospital, Gokhale Road, Naupada, Thane(w) 400602. Maharashtra INDIA
 ● Telefax Nos.: 91-22-25301330 / 31 / 32 ● Skype: nitinkelkarskype ● Gtalk: nkstruments2006



Process Control Instruments for Indication and Control of:

- PRESSURE
- VACCUM
- DP
- FLOW
- VELOCITY
- LEVEL
- TEMPERATURE
- CONDUCTIVITY
- pH
- VIBRATION

MODEL : 5VD

Model for differential pressure gauges with 2 inlets NPT female at bottom and 2 outlets with rotating nuts on top side. Also available in 54mm tap spacings model - 5VD54.

Standard connection

Product	Process side	Instrument side	Vent/Test
5VD	1/2" NPT female	1/2" BSP Rotatable nuts	1/4" NPT female

MODEL : 5VQ

Model designed for complete isolation of instruments-2 inlets NPT female at front, 2 outlets NPT female at back side. Vent/test connection at front, equalizing bonnets (2) angular top, isolating bonnets at left and right side, venting bonnet angular on top

Standard connection

Product	Process Side	Instrument Side	Vent/Test
5VQ	1/2" NPT female	1/2" NPT female	1/4" NPT female



CONTACT DETAILS

B-501/504, 5th floor, Raunak Arcade, Near THC Hospital, Gokhale Road, Naupada, Thane(w) 400602. Maharashtra INDIA
 ● Telefax Nos.: 91-22-25301330 / 31 / 32 ● Skype: nitinkelkarskype ● Gtalk: nkinstruments2006



Process Control Instruments for Indication and Control of:

- PRESSURE
- VACCUM
- DP
- FLOW
- VELOCITY
- LEVEL
- TEMPERATURE
- CONDUCTIVITY
- pH
- VIBRATION

MODEL : 5VV

Model designed for complete isolation of instruments with NPT female inlets / outlets. Vent / test connection at bottom ; equalizing bonnets angular on top venting bonnets at left & right side.

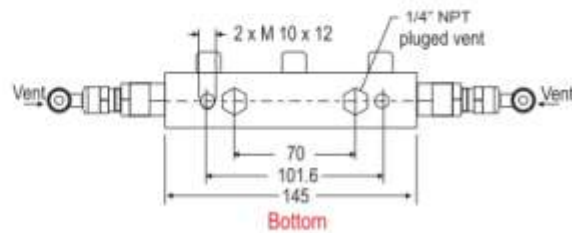
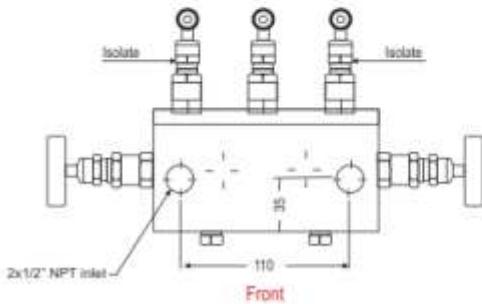
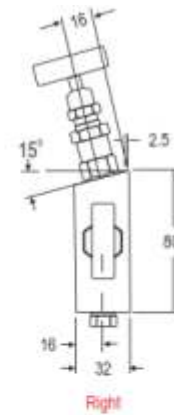
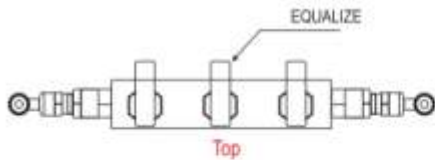
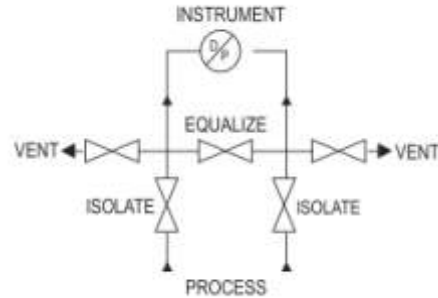

STANDARD CONNECTION

Product	Process Side	Instrument Side	Vent/Test
5VV	1/2" NPT female	1/2" NPT female	1/4" NPT female



CONTACT DETAILS

B-501/504, 5th floor, Raunak Arcade, Near THC Hospital, Gokhale Road, Naupada, Thane(w) 400602. Maharashtra INDIA
 ● Telefax Nos.: 91-22-25301330 / 31 / 32 ● Skype: nitinkelkarskype ● Gtalk: nkstruments2006



PRESSURE	VACCUM	DP	FLOW	VELOCITY	LEVEL	TEMPERATURE	CONDUCTIVITY	pH	VIBRATION
----------	--------	----	------	----------	-------	-------------	--------------	----	-----------

Standard version specifications of model 5VA, 5VG, 5VD, 5VQ, 5VV, 5VR

Body	: SS 316
Stem	: SS 316
Valve assembly	: SS 316
'T' bar handle	: SS 304
Maximum working pressure	: 6000 psi
Maximum working temperature	: 240°C
Packing	: PTFE (Grafoil to be used for temperature above 240°C till 550°C)
Type of stem	: Type CT; Stem with conical metal tip
Drain port	: 1/4" NPT [F]; provided with SS 316 plug
Bracket mounting holes	: 2 Nos.
Chrome plating	: Provided on stem tip.

How to order : Valve Type - 5VA, 5VG, 5VD, 5VQ, 5VV, 5VR

Body Material	Stem Type	Stem Packing	Size = Inlet x Outlet	Connections	Threads
C = Carbon Steel	CT	P = PTFE	44= 1/2" x 1/2" (std)	FF = Female x Female	N = NPT to ANSI B1.20.1
S = SS 316	DS	G = Grafoil	24 = 1/4" x 1/4"	FR = Female x Female	P = BSPF to BS2779
SL = SS 316L				Rotating	B = BSPT to Bs21
M = Monel 400				SW = Socket weld	
H = Hastelloy C					

Options

- GH : Material test certificate
- GO : Hydro test certificate
- IE : Circular plastic.
- TF : Sour gas service to NACE standard MR-01-75.
- SG : Oxygen service. (manifolds are supplied cleaned and degreased)
- DS : Valves with stem having soft conical and delrin tip rolled into the needle for gas service.
- MB : Mounting bracket
- MBC : Mounting bolts [7/16" UNF] in carbon steel
- MBS : Mounting bolts [7/16" UNF] in SS

Example

To place an order simply refer to the codes in the table

VALVE TYPE+	BODY MATERIAL+	STEM TYPE+	STEM PACKING+	SIZE+	CONNECTIONS-	THREADS-	OPTIONS
5VA+	S+	CT+	P+	44+	FF+	N=	FINAL ORDER

NOTE:

The weld prepared types are available with female plain end - suitable for socket weld.
 Anti-tamper bonnet - special design on request with locking arrangement if desired

CONTACT DETAILS

B-501/504, 5th floor, Raunak Arcade, Near THC Hospital, Gokhale Road, Naupada, Thane(w) 400602. Maharashtra INDIA
 ● Telefax Nos.: 91-22-25301330 / 31 / 32 ● Skype: nitinkelkarskype ● Gtalk: nkinstruments2006



PRESSURE	VACCUM	DP	FLOW	VELOCITY	LEVEL	TEMPERATURE	CONDUCTIVITY	pH	VIBRATION
----------	--------	----	------	----------	-------	-------------	--------------	----	-----------

MODEL : 5VP

With threaded horizontal port inlets and Flange port outlets. Three vent/test connections are positioned on the bottom of the body. The isolating, venting and equalizing bonnets are angular positioned on the top designed direct mounting

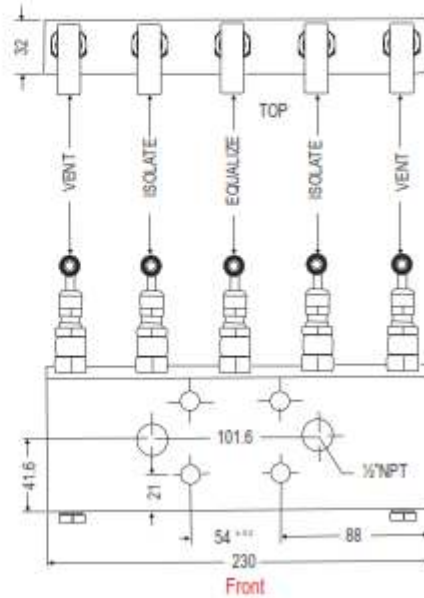
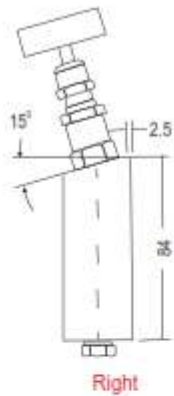
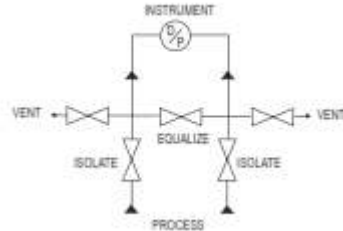

STANDARD CONNECTION

Product	Process Side	Instrument Side	Vent/Test
5VP	1/2" NPT female	1/2" NPT female	1/4" NPT female



CONTACT DETAILS

B-501/504, 5th floor, Raunak Arcade, Near THC Hospital, Gokhale Road, Naupada, Thane(w) 400602. Maharashtra INDIA
 ● Telefax Nos.: 91-22-25301330 / 31 / 32 ● Skype: nitinkelkarskype ● Gtalk: nkstruments2006



MODEL : 5VS

With threaded horizontal port inlets and Flange outlets. Two vent/test connections are positioned on the bottom of the body. The isolating and equalizing bonnets are angular positioned on the top side. The venting bonnets are positioned on the left & right hand side. Designed for direct mounting.

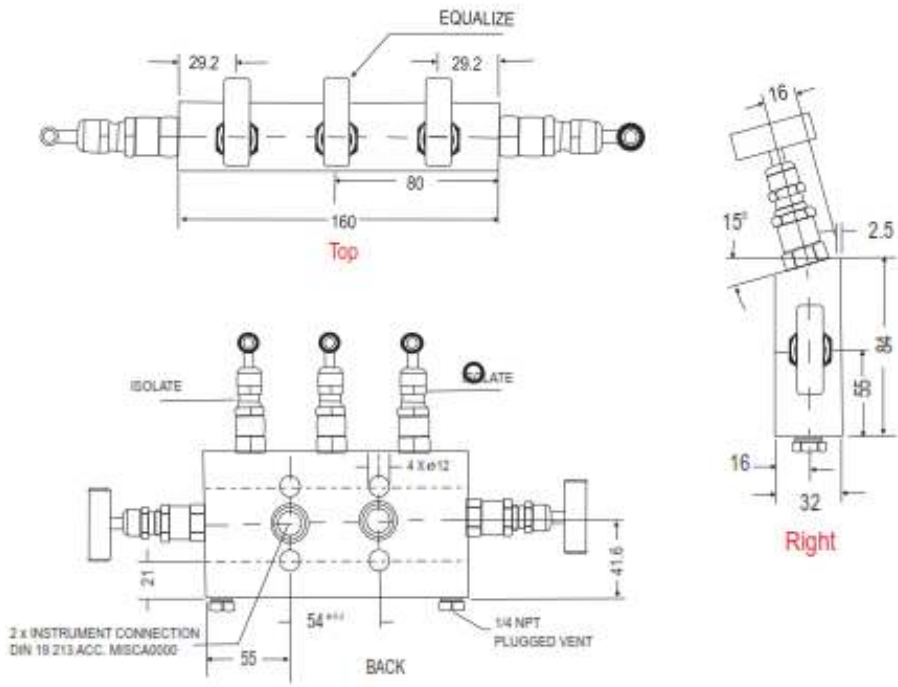
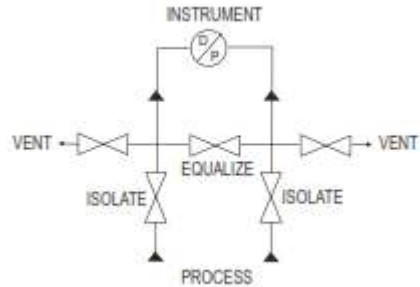

Standard connection

Product	Process side	Instrument side	Vent/Test
5VS	1/2" NPT female	flange	1/4" NPT female



CONTACT DETAILS

B-501/504, 5th floor, Raunak Arcade, Near THC Hospital, Gokhale Road, Naupada, Thane(w) 400602. Maharashtra INDIA
 ● Telefax Nos.: 91-22-25301330 / 31 / 32 ● Skype: nitinkelkarskype ● Gtalk: nkinstruments2006



PRESSURE	VACCUUM	DP	FLOW	VELOCITY	LEVEL	TEMPERATURE	CONDUCTIVITY	pH	VIBRATION
----------	---------	----	------	----------	-------	-------------	--------------	----	-----------

Standard version specifications of model 5VP, 5VS

Body	: SS 316
Stem	: SS 316
Valve assembly	: SS 316
'T' bar handle	: SS 304
Maximum working pressure	: 6000 psi
Maximum working temperature	: 240°C
Packing	: PTFE (Grafoil to be used for temperature above 240°C till 550°C)
Type of stem	: Type CT; Stem with conical metal tip
Drain port	: 1/4" NPT [F]; provided with SS 316 plug
Chrome plating	: Provided on stem tip.

How to order : Valve Type - 5VP, 5VS

Body Material	Stem Type	Stem Packing	Size = Inlet x Outlet	Connections	Threads
C = Carbon Steel	CT(std)	P = PTFE(std)	2F = 1/4" x Flange	FD = Female x Flange(54mm)	N = NPT to ANSI B1.20.1
S = SS 316(std)	DS	G = Grafoil	4F= 1/2" x Flange	SW = Socket Weld	P = BSPP to BS2779
SL = SS 316L					B = BSPT to BS21
M = Monel 400					
H = Hastelloy C					

Options

GH	: Material test certificate
GO	: Hydro test certificate
MBC	: Mounting bolts available [7/16" UNF] in carbon steel
MBS	: Mounting bolts available [7/16" UNF] in SS
IE	: Circular plastic.
TF	: Sour gas service to NACE standard MR-01-75.
SG	: Oxygen service. (manifolds are supplied cleaned and degreased)
DS	: Valves with stem having soft conical and delrin tip rolled into the needle for gas service.
MB	: Mounting bracket

Example

To place an order simply refer to the codes in the table

VALVE TYPE+	BODY MATERIAL +	STEM TYPE+	STEM PACKING+	SIZE+	CONNECTIONS-	THREADS-	OPTIONS
5VP+	S+	CT+	P+	4F+	FD+	N=	FINAL ORDER

NOTE:

The weld prepared types are available with female plain end - suitable for socket weld.
Anti-tamper bonnet - special design on request with locking arrangement if desired

CONTACT DETAILS

B-501/504, 5th floor, Raunak Arcade, Near THC Hospital, Gokhale Road, Naupada, Thane(w) 400602. Maharashtra INDIA
● Telefax Nos.: 91-22-25301330 / 31 / 32 ● Skype: nitinkelkarskype ● Gtalk: nkinstruments2006



Process Control Instruments for Indication and Control of:

PRESSURE	VACCUM	DP	FLOW	VELOCITY	LEVEL	TEMPERATURE	CONDUCTIVITY	pH	VIBRATION
----------	--------	----	------	----------	-------	-------------	--------------	----	-----------

MODEL : 5VN

Five Valve Manifold Special model to accommodate any half DIN 19213 interface complaint pressure transmitter. 2 inlets NPT female at front and 2 outlets Flange at back side DIN 19213. Vent/test connection at front, equalizing bonnets at top side, isolating bonnets at left and right side-venting bonnet at top.

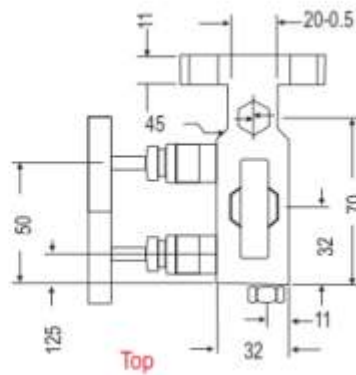
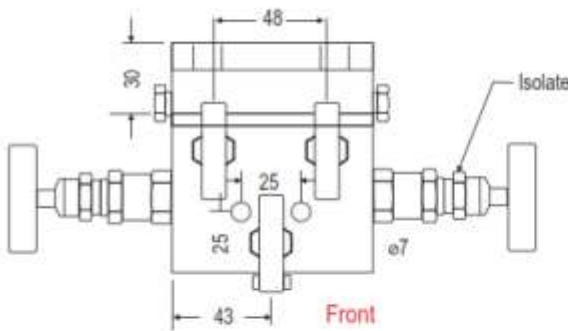
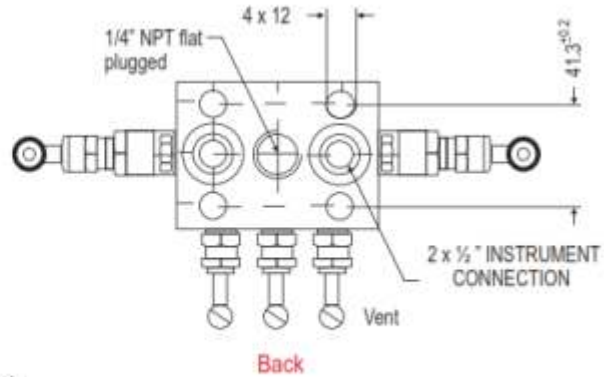
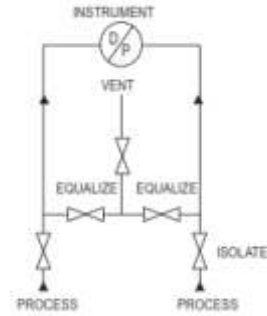

Standard connection

Product	Process side	Instrument side	Vent/Test
5VN	1/2" NPT female	flange	1/4" NPT female



CONTACT DETAILS

B-501/504, 5th floor, Raunak Arcade, Near THC Hospital, Gokhale Road, Naupada, Thane(w) 400602. Maharashtra INDIA
 ● Telefax Nos.: 91-22-25301330 / 31 / 32 ● Skype: nitinkelkarskype ● Gtalk: nkinstruments2006



PRESSURE	VACCUM	DP	FLOW	VELOCITY	LEVEL	TEMPERATURE	CONDUCTIVITY	pH	VIBRATION
----------	--------	----	------	----------	-------	-------------	--------------	----	-----------

MODEL : 5VT

With threaded horizontal port inlets and Flange port outlets. The vent/test ports are positioned on the bottom side. The isolating and venting bonnets are positioned on the left and right hand side and the equalizing bonnet is positioned on the top side.

Designed for direct mounting.

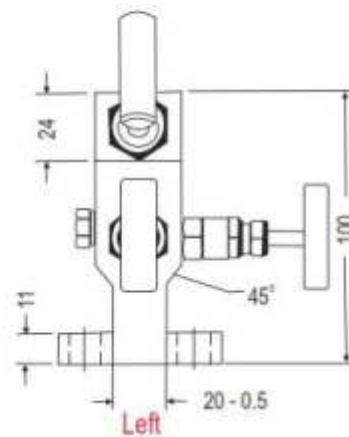
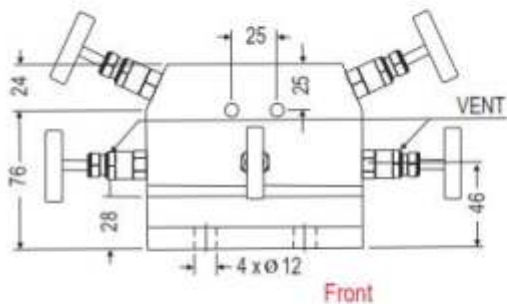
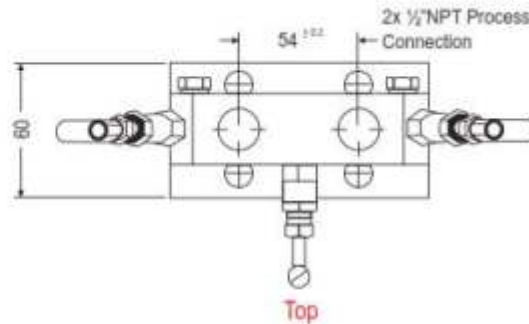
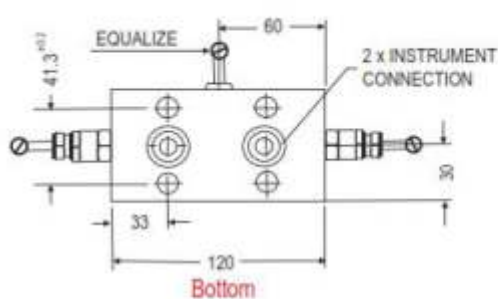
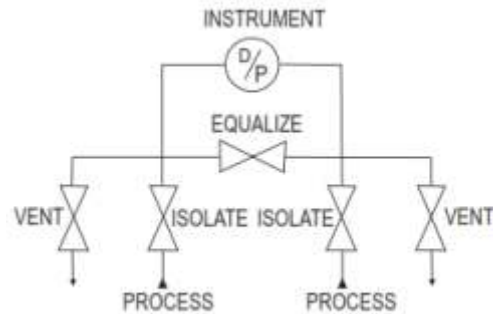

Standard connection

Product	Process side	Instrument side	Vent/Test
5VT	1/2" NPT female	flange	1/4" NPT female



CONTACT DETAILS

B-501/504, 5th floor, Raunak Arcade, Near THC Hospital, Gokhale Road, Naupada, Thane(w) 400602. Maharashtra INDIA
 ● Telefax Nos.: 91-22-25301330 / 31 / 32 ● Skype: nitinkelcarskyype ● Gtalk: nkinstruments2006



PRESSURE	VACCUM	DP	FLOW	VELOCITY	LEVEL	TEMPERATURE	CONDUCTIVITY	pH	VIBRATION
----------	--------	----	------	----------	-------	-------------	--------------	----	-----------

Standard version specifications of model 5VN, 5VT, 5VK, 5VH

Body	: SS 316
Stem	: SS 316
Valve assembly	: SS 316
'T' bar handle	: SS 304
Maximum working pressure	: 6000 psi
Maximum working temperature	: 240°C
Packing	: PTFE (Grafoil to be used for temperature above 240C till 550C)
Type of stem	: Type CT; Stem with conical metal tip
Drain port	: 1/4" NPT [F]; provided with SS 316 plug
Chrome plating	: Provided on stem tip.

How to order : Valve Type - 5VN, 5VT, 5VK, 5VH

Body Material	Stem Type	Stem Packing	Size = Inlet x Outlet	Connections	Threads
C = Carbon Steel	CT(std)	P = PTFE(std)	4F= 1/2" x Flange	FD = Female x Flange (54mm)	N = NPT to ANSI B1.20.1
S = SS 316(std)	DS	G = Grafoil	FF= Flange x Flange	DD = Flange x Flange	P = BSPP to BS2779
SL = SS 316L			2F = 1/4" x Flange	SW = Socket Weld	B = BSPT to BS21
M = Monel 400					
H = Hastelloy C					

Options

GH	: Material test certificate
GO	: Hydro test certificate
MBC	: Mounting bolts available [7/16" UNF] in carbon steel
MBS	: Mounting bolts available [7/16" UNF] in SS
IE	: Circular plastic.
TF	: Sour gas service to NACE standard MR-01-75.
SG	: Oxygen service. (manifolds are supplied cleaned and degreased)
DS	: Valves with stem having soft conical and delrin tip rolled into the needle for gas service.
MB	: Mounting bracket

Example

To place an order simply refer to the codes in the table

VALVE TYPE+	BODY MATERIAL +	STEM TYPE+	STEM PACKING+	SIZE+	CONNECTIONS-	THREADS-	OPTIONS
5VN+	S+	CT+	P+	4F+	FD+	N=	FINAL ORDER

NOTE:

The weld prepared types are available with female plain end - suitable for socket weld.
 Anti-tamper bonnet - special design on request with locking arrangement if desired

CONTACT DETAILS

B-501/504, 5th floor, Raunak Arcade, Near THC Hospital, Gokhale Road, Naupada, Thane(w) 400602. Maharashtra INDIA
 ● Telefax Nos.: 91-22-25301330 / 31 / 32 ● Skype: nitinkelkarskype ● Gtalk: nkinstruments2006



Process Control Instruments for Indication and Control of:

PRESSURE	VACCUM	DP	FLOW	VELOCITY	LEVEL	TEMPERATURE	CONDUCTIVITY	pH	VIBRATION
----------	--------	----	------	----------	-------	-------------	--------------	----	-----------

MODEL : 5V45

Special Five Valve Manifold designed to suit FR 3051 transmitters - inlet NPT female at front - outlet Flange to DIN 19213 at back side - vent/test connection at back, equalizing bonnet on top: isolating left and right side

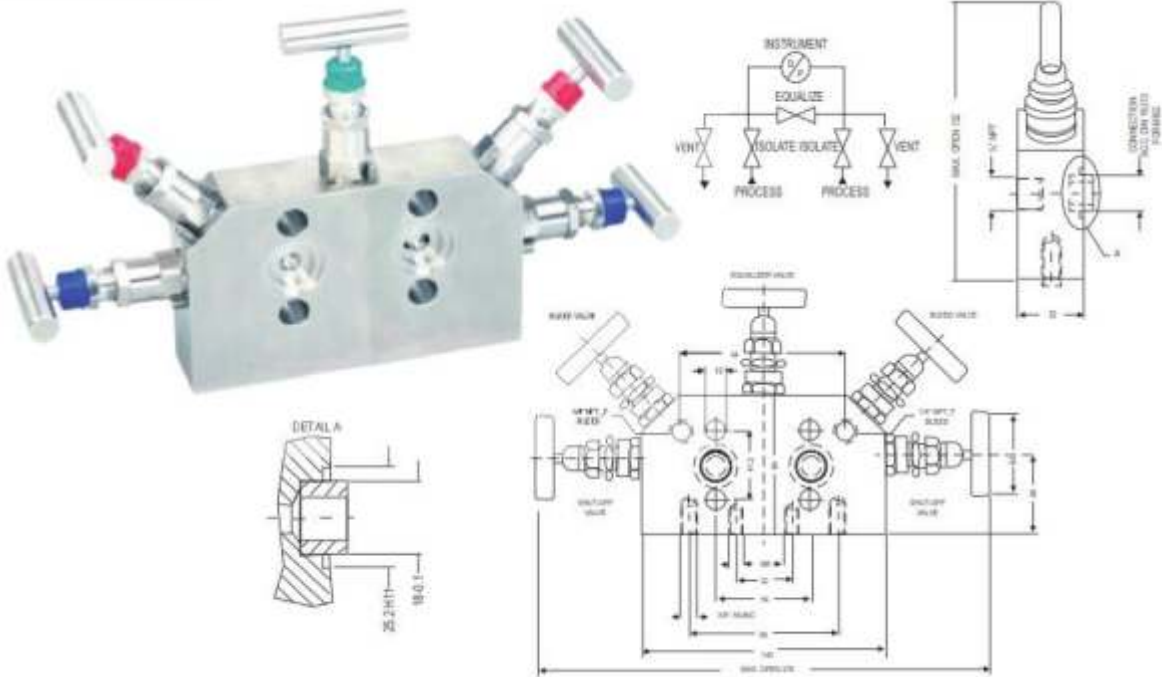

MODEL : 5VZ

Special Five Valve Manifold with threaded inlet and outlet ports. The isolating, equalizing and vent bonnets are all positioned on top.

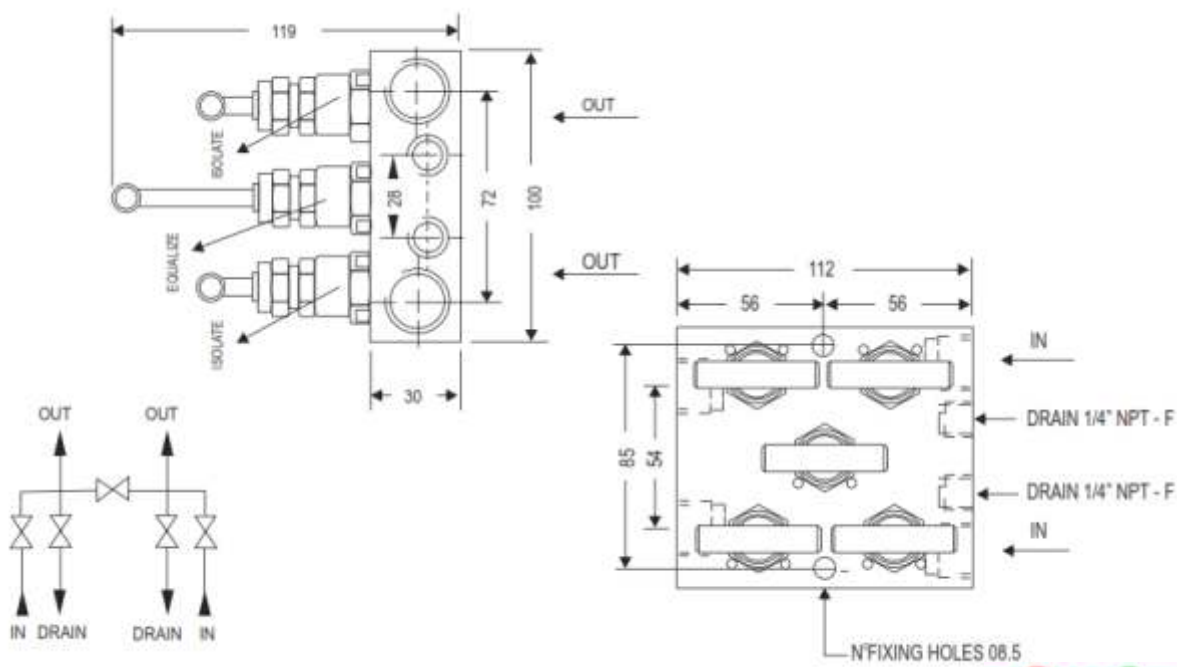

CONTACT DETAILS

B-501/504, 5th floor, Raunak Arcade, Near THC Hospital, Gokhale Road, Naupada, Thane(w) 400602. Maharashtra INDIA
● Telefax Nos.: 91-22-25301330 / 31 / 32 ● Skype: nitinkelkarskype ● Gtalk: nkinstruments2006

